

120 Itr Wheelie Bin Specification Sheet

Features

- Manufactured and tested to EN840 - DIN30700. (EN840 is the Europe wide standard for emptying interoperability and handling safety).
- Extra strength comb lift bar.
- Made from virgin material only for extra strength and life.
- Full thickness “flat body” design (Some other bins, with “fluted bodies” that are much thinner, won’t last as long).
- Maximum strength additives for resistance to UV, cold, heat and chemicals. (No corners cut).
- Solid steel galvanised wheel axle with solid wheel tyres.
- Certified compliant with EU the noise protection Directive.
- 100% recyclable at end of life.



Specifications

- Weights:- Rated maximum load 48kg. Dead weight 10.4kg
- Dimensions:-

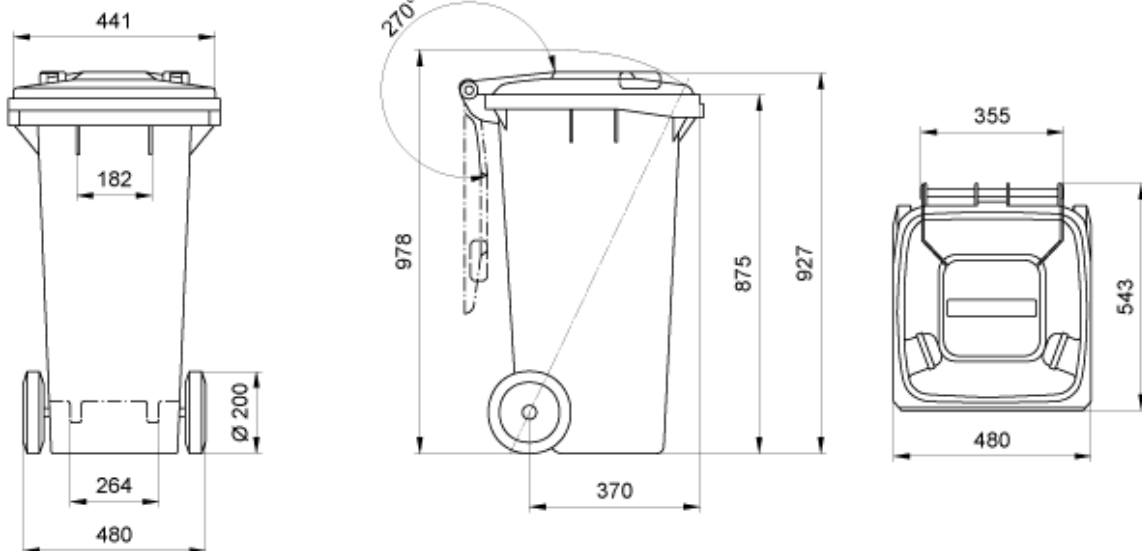

- **Standard Colours:-**
Other colours are available for orders of 1,000+ units

Antracite Grey R7016
Reseda Green R6011
Traffic Red R3020
Sky Blue R5015
Zinc Yellow R1018